

TOP VIEW

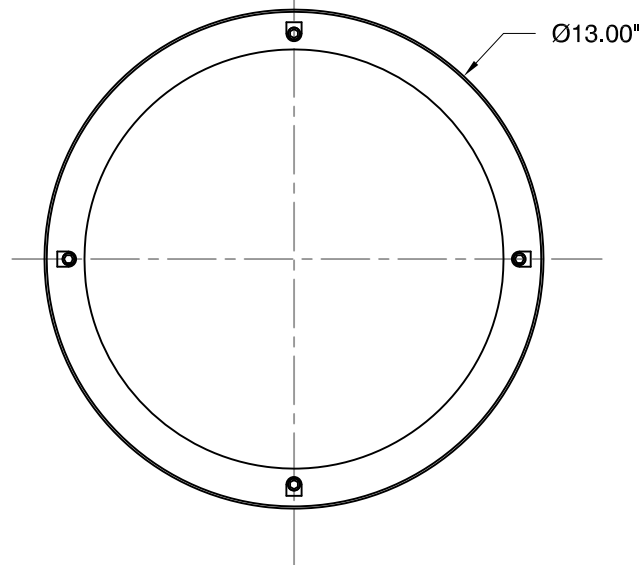

FRONT VIEW

REGIO outdoor
 120v **3-719-6**
 277v **37-719-6**

OXYGEN LIGHTING ©

LAMPING

- o (2x) 10.1w LED Array
- o 3000K, 350mA (ea.)
- o Initial Lumens: 2920 lm
- o Delivered Lumens: TBD
- o CRI > 80
- o Color Consistency: 3 step MacAdam Ellipse

METAL FINISHES

- (All finishes polyester powder coat)
- o 6 - White
 - o 15 - Black
 - o 16 - Gray

DIMENSIONS

- o 13"(Ø) x 4.30" (ext)

SPECIAL NOTE

- o Add caulking around fixture base at the wall to prevent water from entering fixture.

INSTALLATION

- o 4" Octagonal J-Box
- o ETL WET Listed (installer must provide a bead of caulk between fixture housing and mounting surface)
- o Wall or ceiling mount
- o Conforms to UL STD 1598
- o Certified CAN/CSA STD C22.2 No. 250.0

DRIVER (Dimmable)

- o (2x) 0-10v & Reverse Phase Dimming Constant Current 12w, 350mA

INPUT VOLTAGE

- o 120v OR 277v 50/60Hz

Sample Catalog Number

Series #	Finish	Catalog number
3-719	- 16	= 3-719-16



oxygen

OXYGEN LIGHTING
 201 RAILHEAD RD, FORT WORTH, TX 76106
 TEL. (877) 607-0202 FAX (877) 607-0203
 WWW.OXYGENLIGHTING.COM

PROJECT: _____
 DATE: _____

