

FRONT VIEW

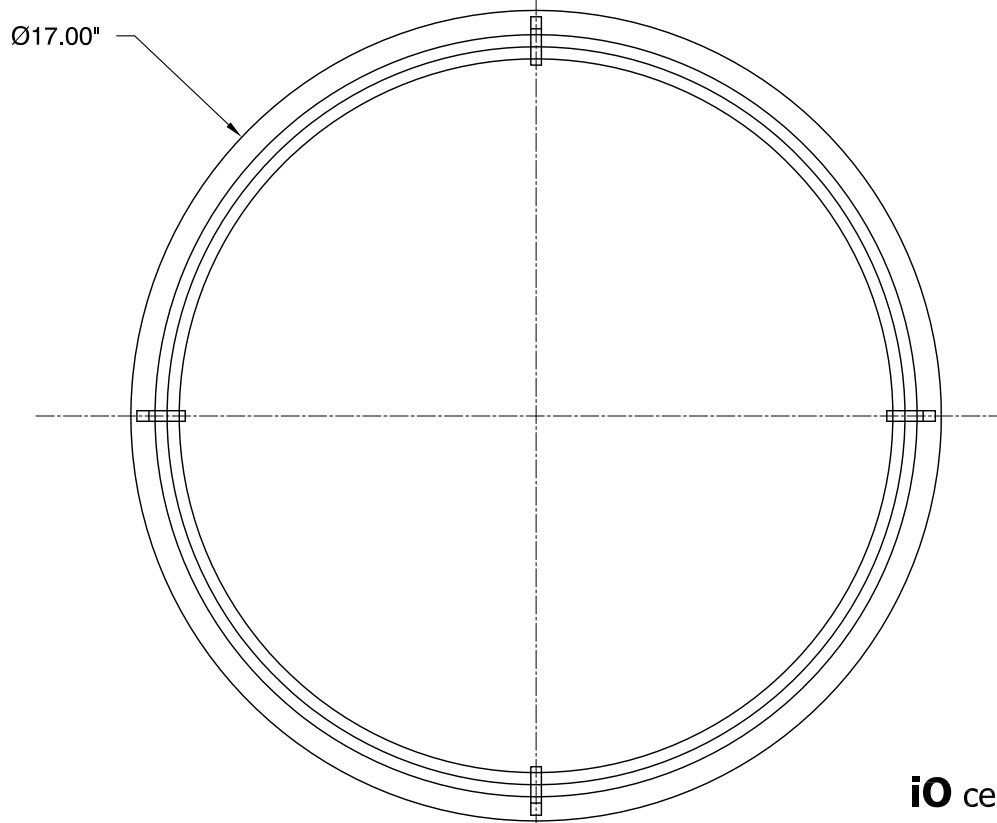

BOTTOM VIEW

iO ceiling mount
 120v **3-689-40**
 277v **37-689-40**

OXYGEN LIGHTING ©

LAMPING

- o (2x) 10.1w LED Arrays
- o 3000K, 350mA (ea.)
- o Initial Lumens: 2920 lm
- o Delivered Lumens: TBD
- o CRI > 80
- o Color Consistency: 3 step MacAdam Ellipse

DRIVER (Dimmable)

- o (2x) 0-10v & Reverse Phase Dimming Constant Current, 12w, 350mA

METAL FINISHES

- o 24 - Satin Nickel
- o 40 - Aged Brass

DIFFUSER

- o Matte White Acrylic

INPUT VOLTAGE

- o 120v OR 277v 50/60Hz

DIMENSIONS

- o Ø17.00" x 4.00"(h)

INSTALLATION

- o 4" Octagonal J-Box
- o ETL Dry/Damp Listed
- o Conforms to UL STD 1598
- o Certified CAN/CSA STD C22.2 No. 250.0



Sample Catalog Number

Series #	Finish	=	Catalog Number
3-689	24	=	3-689-24

oxygen

OXYGEN LIGHTING
 201 RAILHEAD RD, FORT WORTH, TX 76106
 TEL. (877) 607-0202 FAX (877) 607-0203
 WWW.OXYGENLIGHTING.COM

PROJECT: _____

DATE: _____