

TOP VIEW

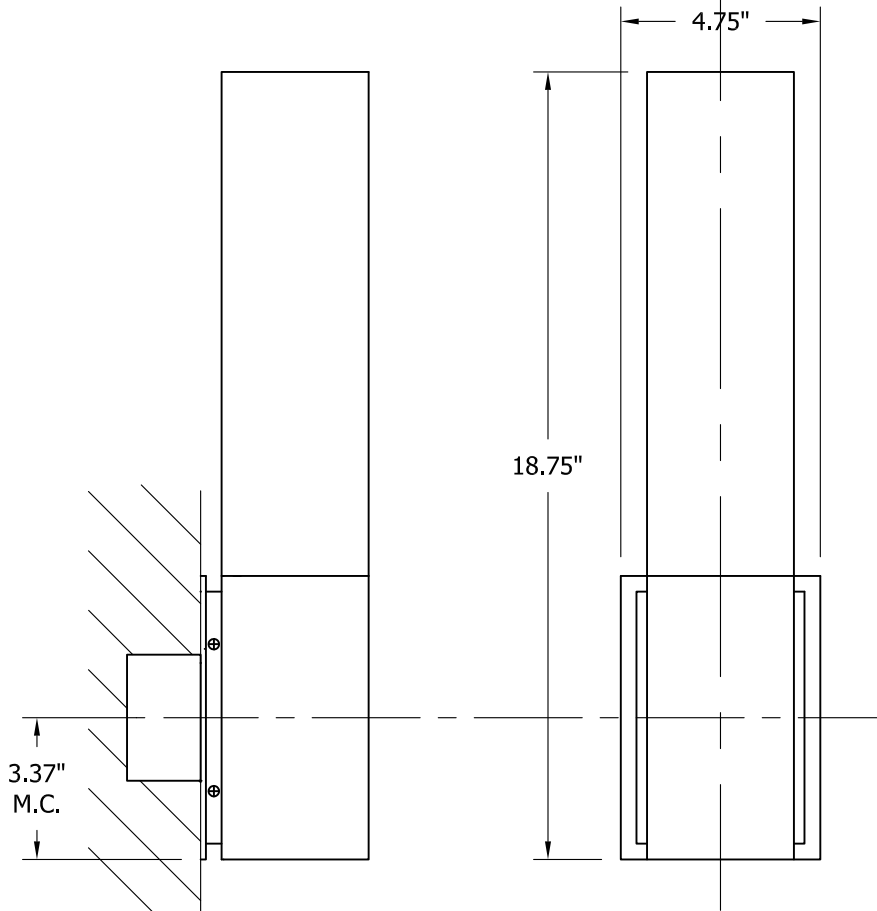

SIDE VIEW

FRONT VIEW

MAGNUM sconce
 120v **3-518-24**
 277v **37-518-24**

OXYGEN LIGHTING ©

LAMPING

- o (1x) 12.2w LED Array
- o 3000k, 350mA
- o Initial Lumens: 1752 lm
- o Delivered Lumens: 970 lm
- o CRI > 80
- o Color Consistency: 3 step MacAdam Ellipse

METAL FINISHES

- o **14** - Polished Chrome
- o **24** - Satin Nickel
- o **25** - Satin Copper
- o **40** - Aged Brass

DIMENSIONS

- o 4.75" (w) x 18.75" (h) x 4.00" (ext.)

INSTALLATION

- o 2" x 3" J-Box or 4" Octagonal J-Box
- o ETL Dry/Damp Listed
- o ADA
- o Conforms to UL STD 1598
- o Certified CAN/CSA STD C22.2 No. 250.0

DRIVER (Dimmable)

- o (1x) 0-10v & Reverse Phase Dimming, Constant Current, 12w, 350mA

INPUT VOLTAGE

- o 120v OR 277v 50/60Hz

DIFFUSER

- o Matte White Acrylic



Sample Catalog Number			
Series #	Finish	=	Catalog Number
3-518	24	=	3-518-24

oxygen

OXYGEN LIGHTING
 201 RAILHEAD RD, FORT WORTH, TX 76106
 TEL. (877) 607-0202 FAX (877) 607-0203
 WWW.OXYGENLIGHTING.COM

PROJECT: _____
 DATE: _____

