

TOP VIEW

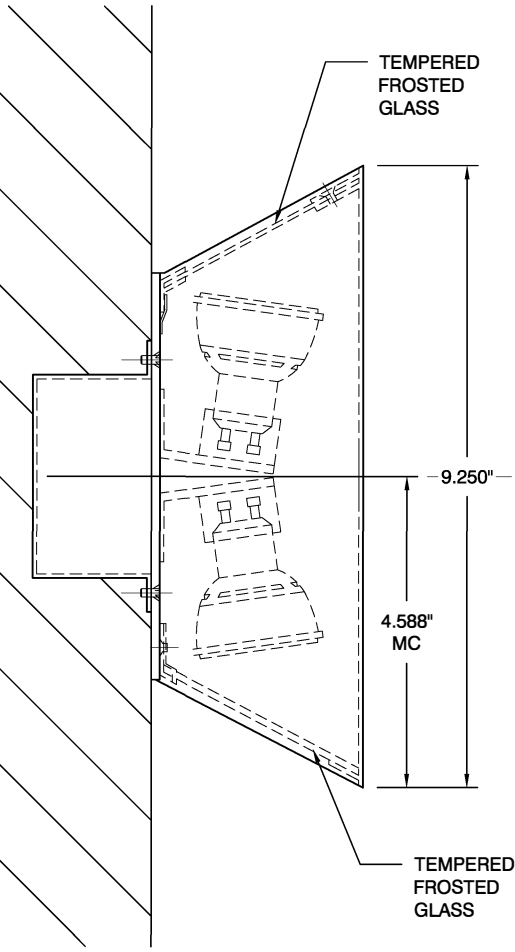

SIDE VIEW

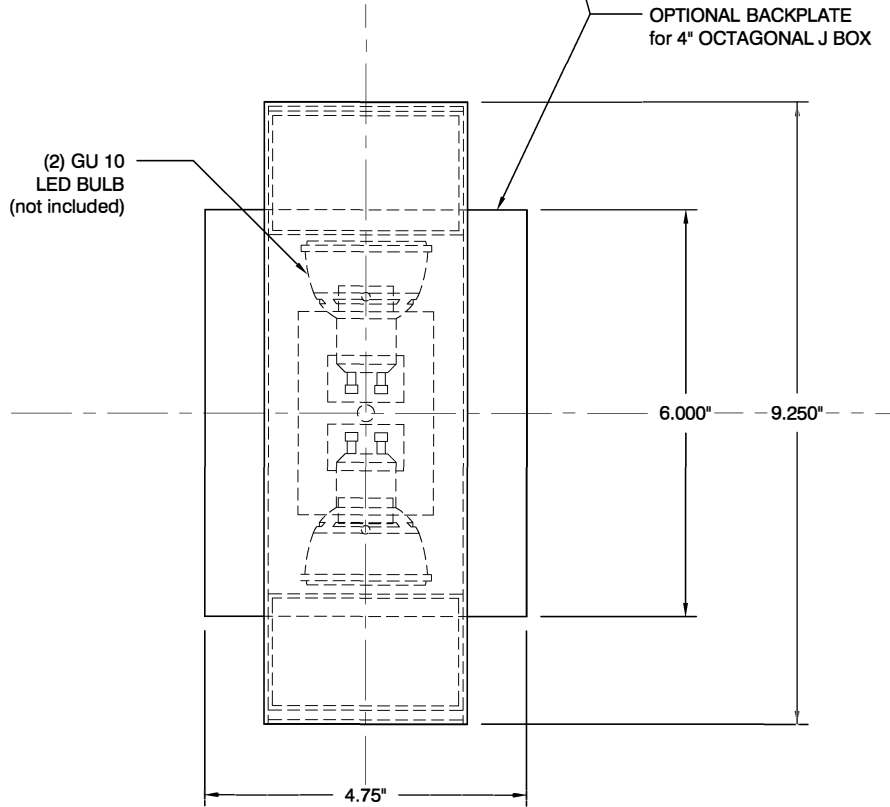

FRONT VIEW

DUO sconce
oxygen **3-509-24**

OXYGEN LIGHTING ©

LAMPING

- o (2x) 7w LED GU10 (not included)
- o 7w MAX
- o GU10 base
- o Initial Lumens (3000K): 1040 lm
- o Delivered Lumens (3000K): 761 lm

METAL FINISHES

- o 14 - Polished Chrome
- o 18 - Gunmetal
- o 24 - Satin Nickel
- o 25 - Satin Copper
- o 40 - Aged Brass

DIMENSIONS

- o 3" (w) X 9.25" (h) X 3" (ext.)
- o With back plate
4.75" (w) X 9.25" (h) X 3.125" (ext.)

INSTALLATION

- o 2" x 3" J-Box
- o 4" octagonal J-Box with optional back plate
- o ADA
- o Conforms to UL STD 1598
- o Certified CAN/CSA STD C22.2 No. 250.0

INPUT VOLTAGE

- o 120v 60Hz

Sample Catalog Number

Series #	Finish	Catalog number
3-509	- 24	= 3-509-24



oxygen

OXYGEN LIGHTING
201 RAILHEAD RD, FORT WORTH, TX 76106
TEL. (877) 607-0202 FAX (877) 607-0203
WWW.OXYGENLIGHTING.COM

PROJECT: _____
DATE: _____

