

TOP VIEW

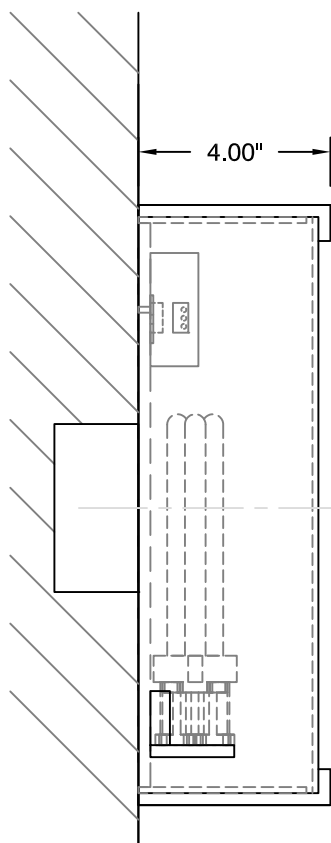

SIDE VIEW

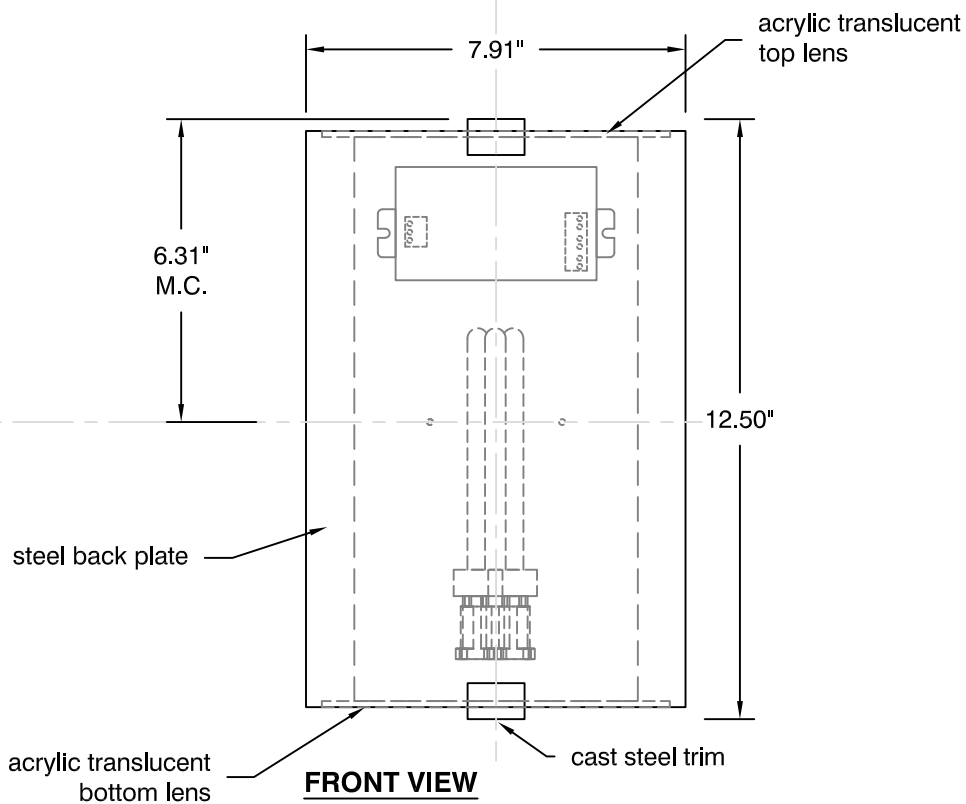

FRONT VIEW

SIREN sconce
oxygen **2-5153-224**

OXYGEN LIGHTING ©

LAMPING

- o 1x26W quad 4-pin fluorescent (G24q-3)
- o Initial Lumens: 1710 lm
- o Delivered Lumens:
 - o 1 - White Opal Glass: 1143 lm
 - o 2 - Matte White Acrylic: 1077 lm

BALLAST

- o Universal Voltage, Electronic HPF Programmed Start

METAL FINISHES

- o 14 - Polished Chrome
- o 24 - Satin Nickel

DIFFUSERS

- o 1 - White Opal Glass
- o 2 - Matte White Acrylic
- o 4 - Faux Onyx Acrylic
- o 6 - Silver Cloth Acrylic

VOLTAGE

- o 120/277V

DIMENSIONS

- o 7.91" (w) x 12.50" (h)
- o 4.00" ext. from wall

INSTALLATION

- o 4" octagonal J-Box
- o UL Damp Listed
- o ADA



Sample Catalog Number

Series #	Diffuser	Finish	Catalog Number
2-5153	- 2	14	= 2-5153-214

oxygen

OXYGEN LIGHTING
201 RAILHEAD RD, FORT WORTH, TX 76106
TEL. (877) 607-0202 FAX (877) 607-0203
WWW.OXYGENLIGHTING.COM

PROJECT: _____
DATE: _____

