

PERSPECTIVE

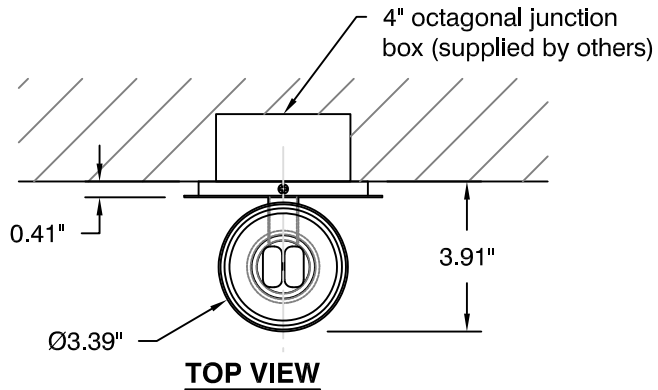

TOP VIEW

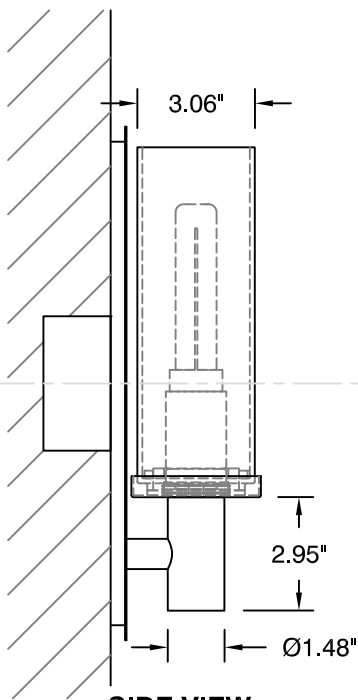

SIDE VIEW

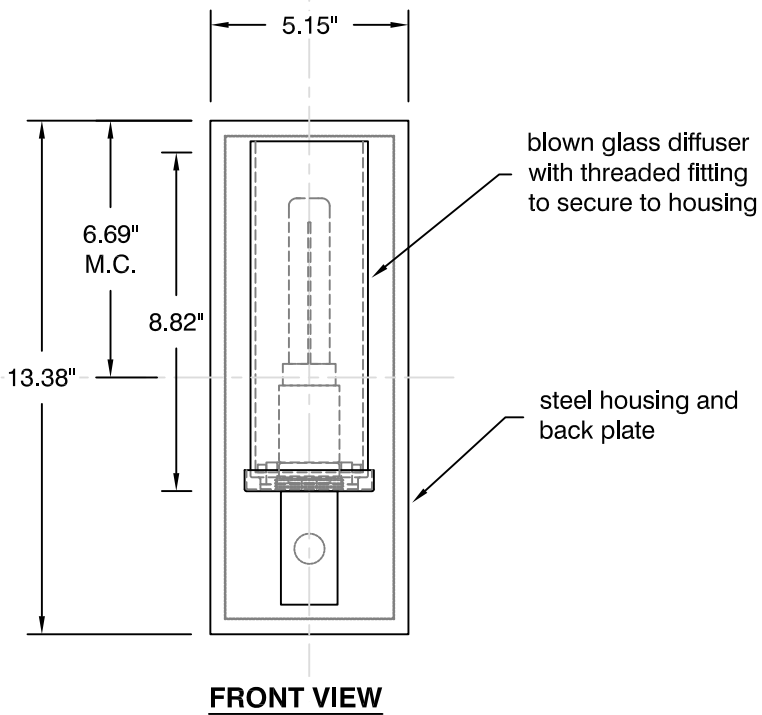

FRONT VIEW

MANTRA sconce
oxygen **2-5127-324**

OXYGEN LIGHTING ©

LAMPING

- o 1x18W quad tube, 4-pin compact fluorescent (G24q-2)
- o Initial Lumens: 1150 lm

BALLAST

- o Electronic NPF, Rapid Start

VOLTAGE

- o 120V

METAL FINISHES

- o 14 - Polished Chrome
- o 24 - Satin Nickel

DIFFUSER

- o White Opal Glass

OPTIONS

- o 3 - Perforated Sleeve

DIMENSIONS

- o 5" (w) x 13.38" (h)
- o 4.00" ext. from wall

INSTALLATION

- o 4" octagonal J-Box
- o UL Damp Listed
- o ADA



Sample Catalog Number

Series #	Finish	Catalog Number
2-5127	- 24	= 2-5127-24

oxygen

OXYGEN LIGHTING
201 RAILHEAD RD, FORT WORTH, TX 76106
TEL. (877) 607-0202 FAX (877) 607-0203
WWW.OXYGENLIGHTING.COM

PROJECT: _____

DATE: _____

